

PMV0402-360E5R0

Features

- Operating voltage: 25 Vrms (36 Vdc)
- Fast response, instantly clamping the transient over voltage.
- High surge current handling capability.
- High energy absorption capability.
- Low clamping voltages, providing better surge protection.
- Low capacitance values, providing digital switching circuitry protection.
- High insulation resistance, preventing electric arcing to the adjacent devices or circuits.
- Meet IEC 61000-4-2 level 4 standard.

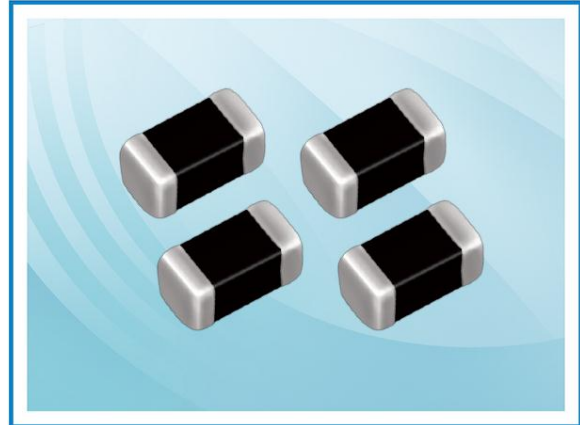

Applications

- Universal Serial Bus (USB).
- Mobile communication.
- Computer/DSP product.
- Video and audio ports.
- Portable/Hand-Held Products.
- Data, Diagnostic I/O ports.

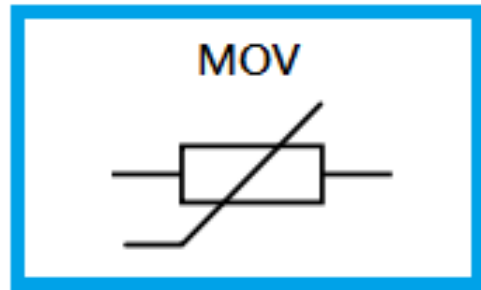

General Characteristics Definition

- Operating temperature: -40 ~ 125°C
- Storage temperature: -40 ~ 125°C

Material

- Electrode: Ag/Ni/Sn
- Chip body: Zinc oxide

Part Number Code

PMV 0402 - 360 E 5R0

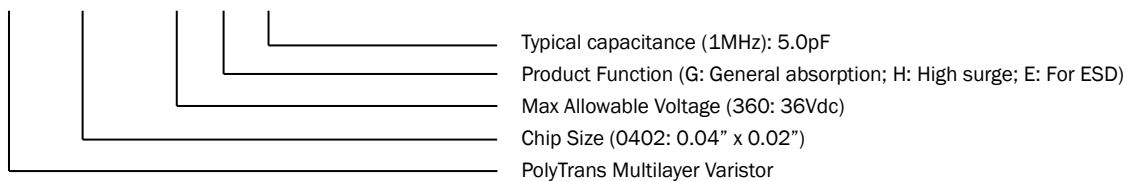

Physical Dimensions

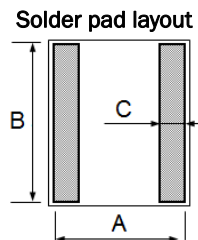
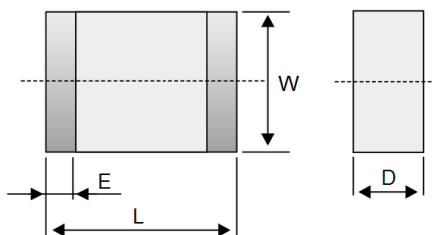

Symbol	Dimension (mm)
L	1.0±0.1
W	0.5±0.1
D	0.6 max.
E	-
A	1.7 typ.
B	0.5 typ.
C	0.6 typ.

Note:

1. All dimensions are in millimeters.
2. No marking on the device.

PMV0402-360E5R0

Electrical Characteristics

Part Number	Max Allowable Voltage		Varistor Voltage $V_b @ 1 \text{ mA}$		Withstand Surge Current I_{PP} 8/20 μs	Max Clamping Voltage V_C		Capacitance @ 1MHz		
	V_{RMS} (V)	V_{DC} (V)	Min (V)	Max (V)		V (V)	I (A)	Min (pF)	Typ (pF)	Max (pF)
	PMV0402-360E5R0	25	36	40	60	1	200	1	3.5	5.0

Peak Pulse Current Test Waveform

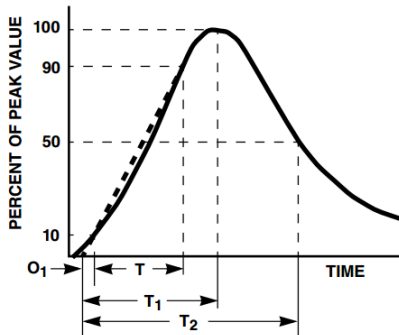

O_1 = Virtual Origin of Wave
 T = Time from 10% to 90% of Peak
 T_1 = Rise Time = $1.25 \times T$
 T_2 = Decay Time

Example - For an 8/20 ms current waveform
 $8 \mu\text{s} = T_1 = \text{Rise Time}$
 $20 \mu\text{s} = T_2 = \text{Decay Time}$

Power Derating Curve

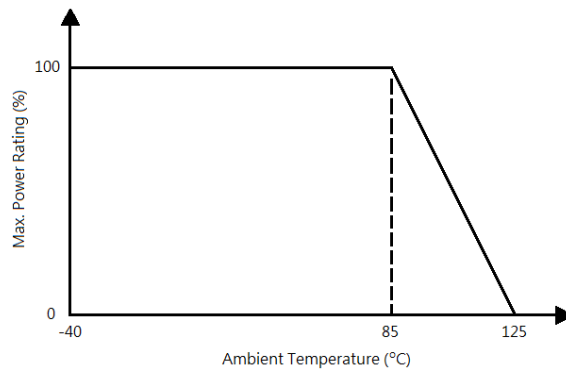

Lead Free Reflow Soldering Recommendations

Preheat	
- Temperature Min (T_{s_min})	150°C
- Temperature Max (T_{s_max})	200°C
- Time (T_{s_min} to T_{s_max})	60-180 seconds
- Average Ramp-Up Rate	1~3°C/second
Peak Temperature	260°C max.
Time within 5°C of actual Peak Temperature (t_p)	40 seconds max.
Ramp-Down Rate	6 °C /second max.

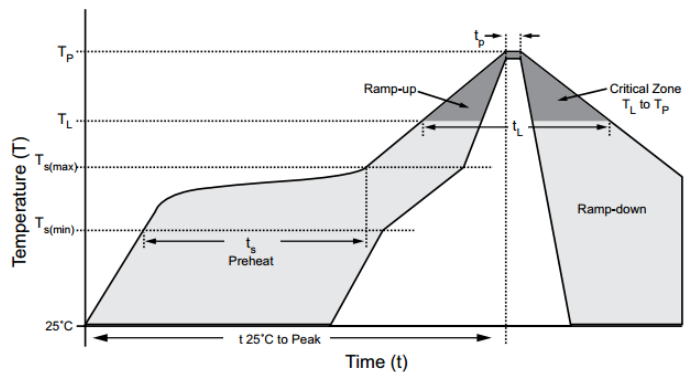

Note: If the wave soldering temperatures exceed the recommended profile, devices may not meet the performance requirements.

PMV0402-360E5R0

Reliability Test

Environmental Ratings										
Test Parameter	Test Condition / Description	Performance Requirements								
Dry Heat Loading	The specimen shall be applied continuously the maximum allowable voltage at the specified conditions for specified period and then stored at room temperature and normal humidity over 2 hours. Thereafter, the change of V_b and mechanical damage shall be examined. Ambient temp: $85\pm 2^\circ\text{C}$ / Period: 1000 ± 24 hours	$\Delta V_b/V_b \leq 10\%$								
High Temp Storage	In a dry oven without load. Ambient temp: $125\pm 2^\circ\text{C}$ / Period: 1000 ± 24 hours	$\Delta V_b/V_b \leq 10\%$								
Damp Heat/ Humidity Loading	The specimen shall be applied continuously the maximum allowable voltage at the specified conditions for specified period and then stored at room temperature and normal humidity over 2 hours. Thereafter, the change of V_b and mechanical damage shall be examined. Ambient temp: $40\pm 2^\circ\text{C}$, 90~95%RH / Period: 1000 ± 24 hours	$\Delta V_b/V_b \leq 10\%$								
Temperature Cycle	Condition the specimen to each temperature from step 1 to step 4 in this order for the period shown in the table of specifications. The change of V_b and mechanical damage shall be examined after 2 hours. <table border="1" style="margin: 10px auto;"> <tr> <td style="text-align: center;">Step 1</td> <td style="text-align: center;">$-40\pm 3^\circ\text{C}$ / 30min.</td> </tr> <tr> <td style="text-align: center;">Step 2</td> <td style="text-align: center;">Room temp / 15min.</td> </tr> <tr> <td style="text-align: center;">Step 3</td> <td style="text-align: center;">$85\pm 2^\circ\text{C}$ / 30min.</td> </tr> <tr> <td style="text-align: center;">Step 4</td> <td style="text-align: center;">Room temp / 15min.</td> </tr> </table>	Step 1	$-40\pm 3^\circ\text{C}$ / 30min.	Step 2	Room temp / 15min.	Step 3	$85\pm 2^\circ\text{C}$ / 30min.	Step 4	Room temp / 15min.	No Visible damage $\Delta V_b/V_b \leq 10\%$
Step 1	$-40\pm 3^\circ\text{C}$ / 30min.									
Step 2	Room temp / 15min.									
Step 3	$85\pm 2^\circ\text{C}$ / 30min.									
Step 4	Room temp / 15min.									
Low Temp Storage	In a cooling chamber without load. Ambient temp: $-40\pm 2^\circ\text{C}$ / Period: 1000 ± 24 hours	$\Delta V_b/V_b \leq 10\%$								

Packaging Information

Part Number	Quantity (EA/Roll)	Reel Dimension (mm)	
		Diameter	Thickness
PMV0402-360E5R0	10000	178.0 ± 1.0 (7" Paper Reel)	9.0 ± 0.5

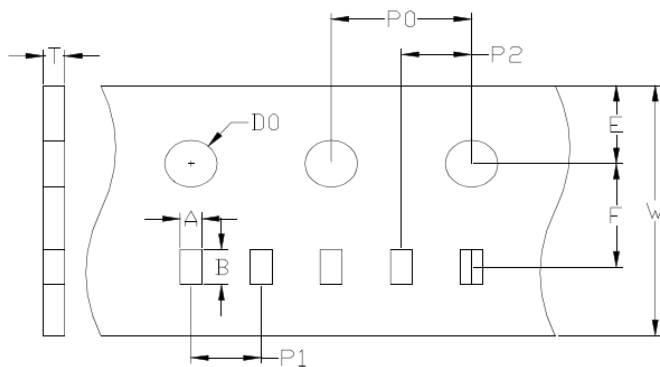

Symbol	Dimension (mm)
P1	2.0 ± 0.1
P2	2.0 ± 0.1
P0	4.0 ± 0.1
D0	1.55 ± 0.05
E	1.7 ± 0.1
F	3.5 ± 0.1
W	8.0 ± 0.2
T	0.60 ± 0.05
A	0.60 ± 0.05
B	1.10 ± 0.05